

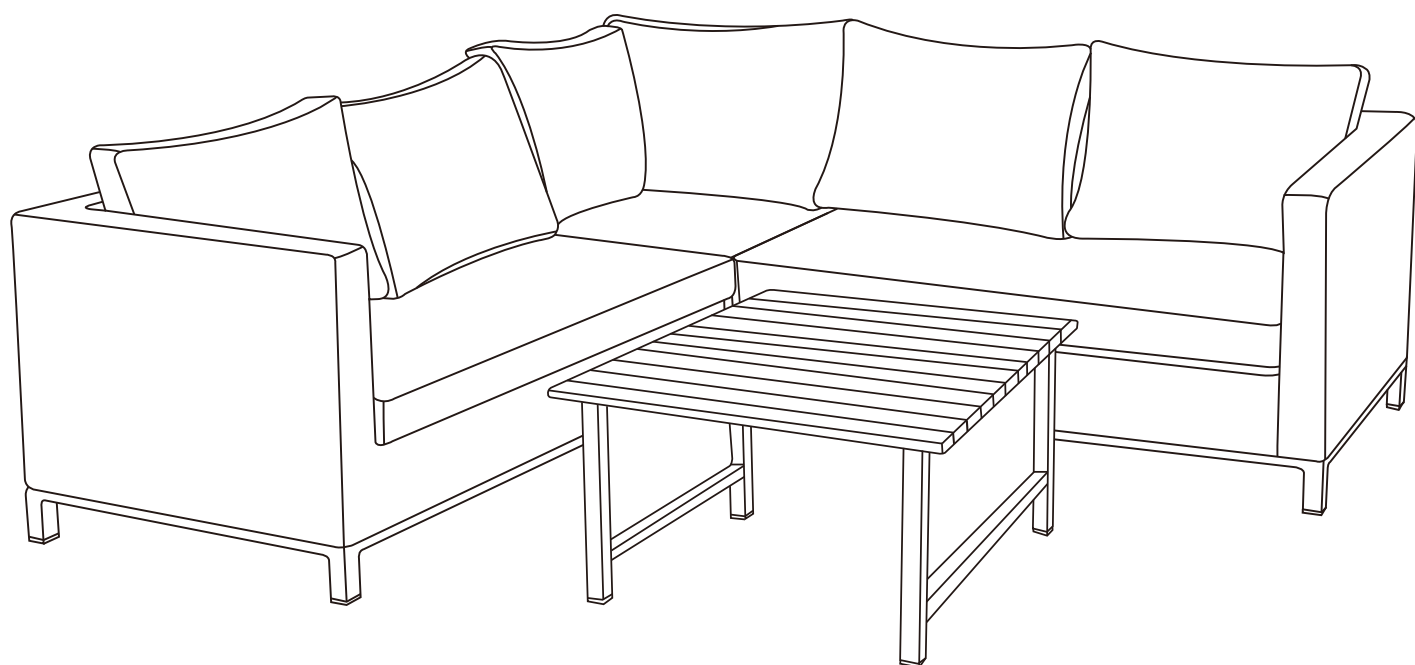





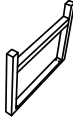

TURIN

1288_93800

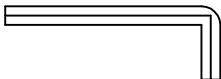
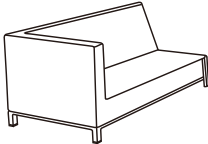
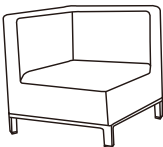
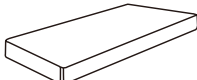

1288_93800

A		895x895x29mm	1	1/3
B		865x450x40mm	2	1/3
C		M6x30mm	8	1/3
D		M6	8	1/3
E		S4	1	1/3
F		1360x830x700mm	2	3/3
G		830x830x700mm	1	2/3
H		1250x640x100mm	2	3/3
I		640x640x100mm	1	2/3
J		770x460x80mm	1	2/3
K		600x460x80mm	1	2/3
L		640x470x80mm	4	3/3

FR : SAV/INFORMATION /VIDEO/CONTACT

EN: AFTER-SALES SERVICE/INFORMATION/VIDEO/CONTACT

DE : REPARATUR-SERVICE UND ERSATZTEILE /INFORMATIONEN /VIDEO/KONTAKT

ES: SERVICIO POST-VENTA/INFORMACIÓN/VIDEO/CONTACTO

IT: SERVIZIO ASSISTENZA/INFORMAZIONI/VIDEO/CONTATTO

PT: SERVIÇO PÓS-VENDA/INFORMAÇÕES/VIDEO/CONTATO

PL: SERWIS TECHNICZNY/INFORMACJE/WIDEO/KONTAKT

NE: AFTER SALES SERVICE/INFORMATIE/VIDEO/CONTACT

HE: מע רשקתל/ואדיווה/ עדימ/תורכימו תוריש רחאל

SAV.HABITATETJARDIN.COM

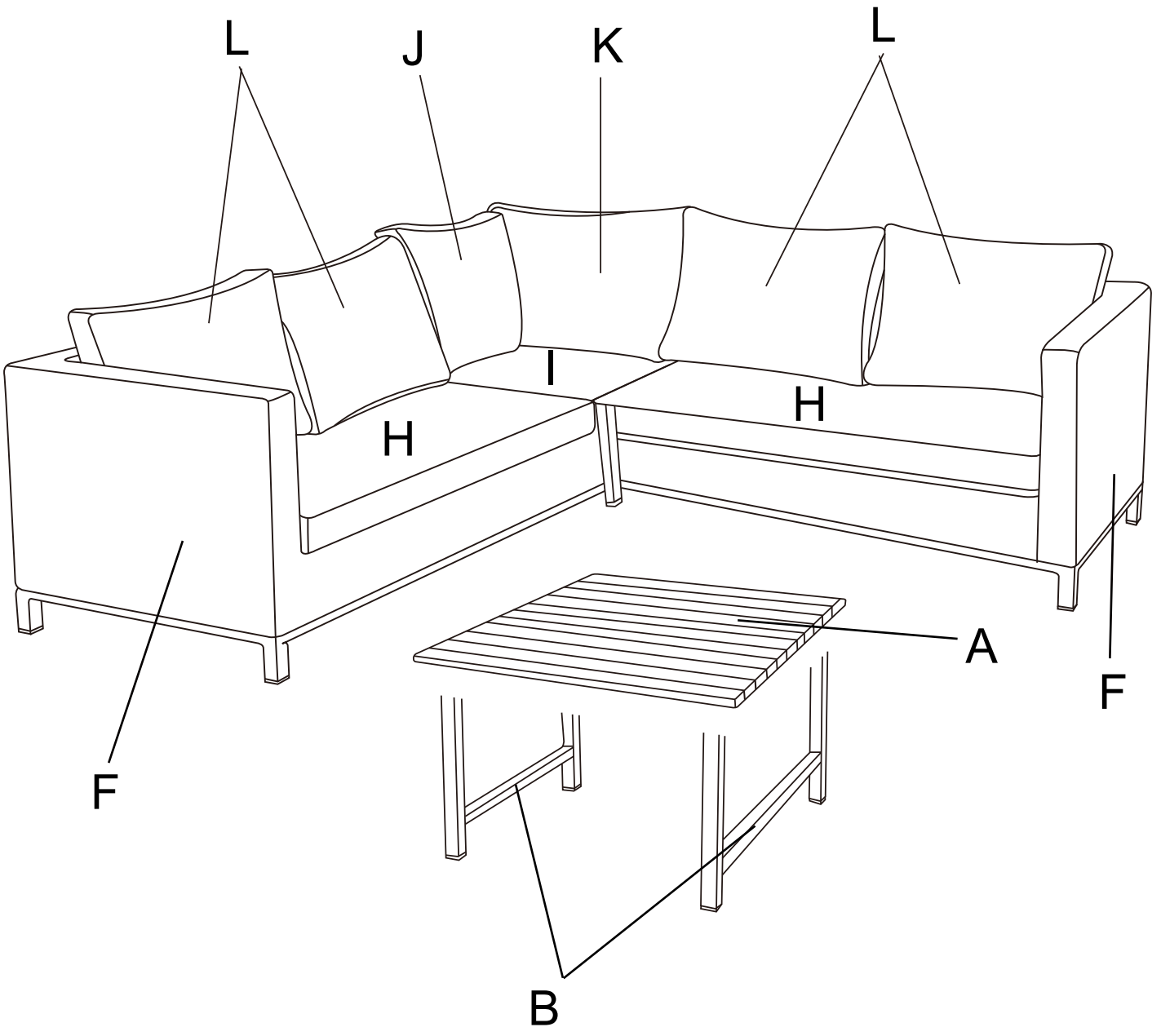

FR

- Il est conseillé d'attendre d'avoir monté entièrement votre produit avant de serrer complètement vos vis.
- Il est conseillé de protéger vos produits à l'aide d'une housse de protection afin de les préserver des intempéries et de la poussière.
- Séchez votre mobilier aussi tôt pour éviter les traces.
- En hiver, stockez vos produits à l'abri dans un endroit sec.
- Ne jamais utiliser des produits chimiques pour le nettoyage.

EN

- It is advisable to wait until you have fully assembled your product before tightening your screws completely.
- It is advisable to put your products into cover to protect them from the severe weather and dust.
- Dry your furniture as early as possible to avoid traces.
- In winter, store your products in a dry place.
- Never use chemical products for cleaning.

DE

- Es ist ratsam, für Ihre vollständig montiert zu warten, bevor vollständig Ihre Schrauben festziehen.
- Es wird empfohlen, Ihre Produkte mit einer Schutzabdeckung zum Schutz vor Witterung und Staub zu schützen.
- Trocknen Sie Ihre Möbel zu früh Spek zu verhindern.
- Im Winter, speichern Sie Ihre Waren an einem trockenen Ort.
- Verwenden Sie niemals Chemikalien zur Reinigung.

ES

- Se aconseja montar totalmente el producto antes de apretar completamente todos los tornillos.
- Se aconseja cubrir los productos con una funda para protegerlos de las intemperies y del polvo.
- Seque inmediatamente su mobiliario para evitar las marcas.
- En invierno, almacene los productos en un lugar seco.
- Nunca utilice productos químicos para la limpieza.

IT

- È consigliato di aspettare di avere montato interamente il prodotto prima di stringere completamente le viti.
- È consigliato di proteggere i prodotti con un sacco di protezione per preservarli dal brutto tempo e dalla polvere.
- Subito asciugare I prodotti per non avere tracce.
- Durante l'inverno, mettere I prodotti al riparo in un luogo secco.
- Mai usare prodotti chimici per pulire I prodotti.

